

Part No: 158151TP  
 Sidewind Leg.  
 Lifting Cap: 900kgs  
 Stroke: 400mm

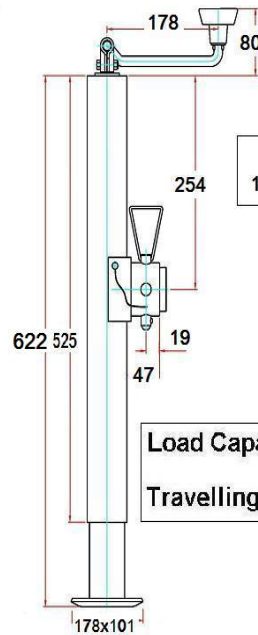

Part no:  
 158452TP

Load Capacity: 900kgs  
 Travelling Stroke: 381mm

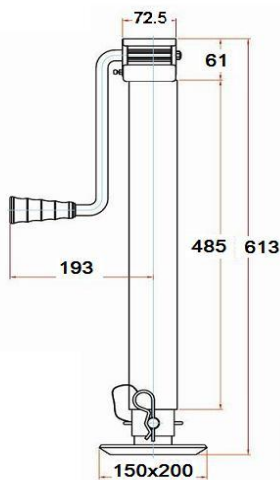

Part no: 190510  
 Load capacity: 3175kgs  
 Stroke: 381mm  
 Drop section: 340mm

Part no: 190754ND  
 No Dropleg.  
 Closed ht: 545mm  
 Capacity: 2500kgs

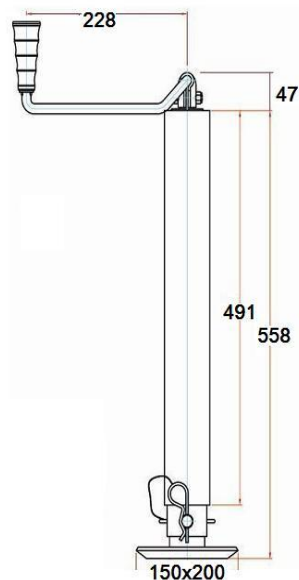

Part No: 190510TW  
 Load capacity: 3175kgs  
 Stroke: 381mm  
 Dropleg section: 340mm

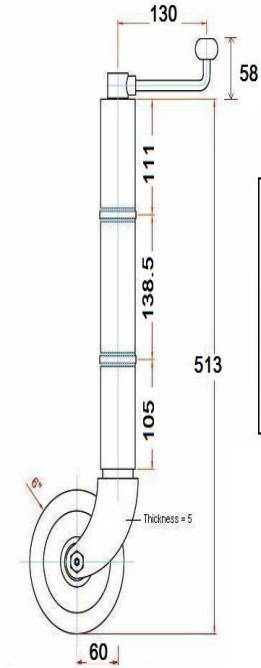

Part No: SS109  
 Jockey Wheel with clamp bracket.  
 Load capacity: 226 kgs  
 Extended: 764mm  
 Retracted: 510mm  
 Stroke: 254mm  
 6" Wheel

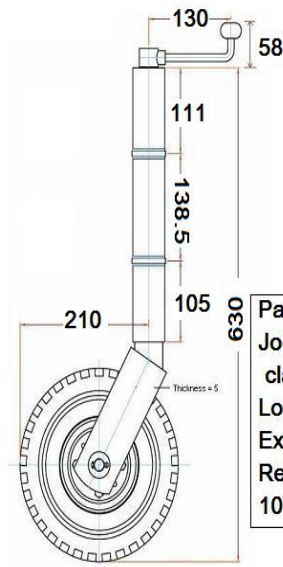

Part No: SS115  
 Jockey Wheel with clamp bracket.  
 Load cap: 226kgs  
 Extended: 829mm  
 Retracted: 575mm  
 10" Wheel

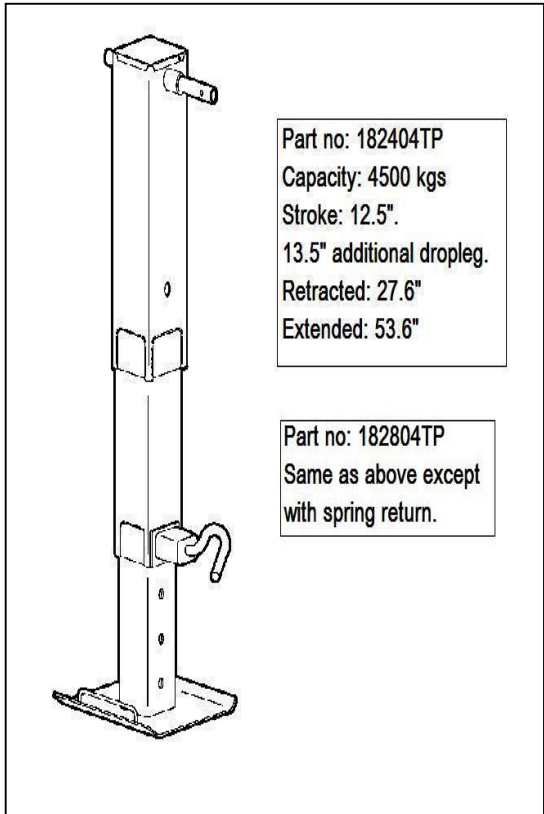

Part no: 182404TP  
 Capacity: 4500 kgs  
 Stroke: 12.5".  
 13.5" additional dropleg.  
 Retracted: 27.6"  
 Extended: 53.6"

Part no: 182804TP  
 Same as above except  
 with spring return.



Part No: FD2  
 Capacity: 5000kgs

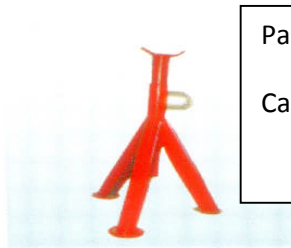

Part No: YD1  
 Capacity: 500kgs